

## EC Declaration of Conformity

**We:** Marconi Interactive Systems  
**Of:** Carr Lane, Chorley, Lancashire, PR7 3JP UK  
**Declare that model number:** Contour 50  
**Equipment:** Coin payphone for customer: British Telecom  
**Network connection type:** PSTN Class 1.2

is (are) in conformity with the requirements of the R&TTE directive.

Directive 1999/5/EC of the European Parliament and of the Council  
9 March 1999

Compliance is achieved by conformity to the following:

EN60950: 1992 (Generic Safety)  
EN55022: 1998 (EMC Generic Emissions)  
EN55024: 1998 (EMC Generic Immunity)

Authorised by



Colin McArdle  
V.P. Product Development (on behalf of MIS)

**Date of issue** 15 June 2001

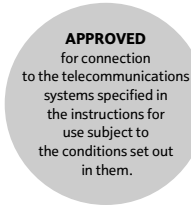

The Payphone Contour 50  
conforms with European Directive  
R & TTE 1999/5/EC



### Offices worldwide

The telecommunications services described in this publication are subject to availability and may be modified from time to time. Services and equipment are provided subject to British Telecommunications plc's respective standard conditions of contract. Nothing in this publication forms part of any contract.

© British Telecommunications plc 2001  
Registered office: 81 Newgate Street, London EC1A 7AJ  
Registered in England No. 1800000  
Produced by BT Payphones  
Designed by Enterprise IDU  
Printed in the UK

PHME 38049/9.2001

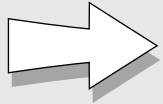
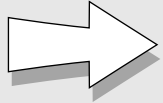
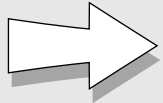

***BT Contour 50  
User guide***



# Contents

## Everyday features

### *Making and answering calls*

Making a normal payphone call . . . . .	4
To redial the last number you dialled . . .	5
Making a call using a Memory button . . .	5
Making an Owner call using your PIN . . . .	6
Making an Owner call using your cash box key . . . . .	6
Answering calls . . . . .	7

### *Money*

Emptying the cash box . . . . .	8
Checking the total money taken using your PIN . . . . .	9
Checking the total money taken using the cash box key . . . . .	9

## Extra features

How to get started . . . . .	11
------------------------------	----

### *Barring*

Barring certain outgoing calls . . . . .	12
Barring calls made with fake coins or tokens . . . . .	13
Barring incoming calls . . . . .	14
Setting the ringer switch . . . . .	15
Barring old coins from being used . . . . .	16

## Call handling

Withholding your number . . . . .	17
Setting the identification tone . . . . .	18
Setting the Operator tone . . . . .	19
Setting the privacy feature . . . . .	20
Setting an automatic switchboard code . . .	21
Setting a manual switchboard code . . . .	22
Removing a switchboard code . . . . .	23

## Charging

Setting call charges . . . . .	24
Setting the minimum fee . . . . .	25
Programming new coins or tokens . . . . .	26
Programming exception codes . . . . .	27
Cancelling exception codes . . . . .	28
Charging for calls to Directory Enquiries	28

## Payphone settings

Setting the payment timer . . . . .	29
Programming the Memory buttons . . . . .	30
Setting the time and day . . . . .	32
Changing your PIN . . . . .	33
Setting the dialling mode . . . . .	33

## Troubleshooting . . . . . 34

## Technical information . . . . . 38

## Index . . . . . 39

## Important information

**Make a note of your BT Contour 50 Payphone serial number** which is printed on the bottom of your phone

**Your cash box key number**

If you need any help, please visit our website at [www.bt.com/payphones](http://www.bt.com/payphones)

If you need to contact us, please send an email with your query to [product.help.payphones@bt.com](mailto:product.help.payphones@bt.com) or call the **Payphone Helpdesk** free on **0800 25 25 41** and we will be pleased to help you. Lines are open Monday to Saturday, 8am to 6pm.

If you need replacement cash box keys, please call the **Tetrel Key Helpdesk** free on **0800 373 085**.

If you would like to speak to our Sales Team, please call the **Payphone Sales Desk** free on **0800 11 55 11**. Lines are open Monday to Friday, 8am to 6pm and Saturday from 9am to 2pm.

# *Everyday features*

These are the most common features and functions, which you will probably use most often. For any other features, see the *Extra features* section on page 10.

## **Making and answering calls**

▶ page 4

These instructions will tell you how to use the payphone for making and answering normal calls, and for making Owner calls.

If you want to make an Owner call – where you don't have to put in any cash and the calls you make are charged to your normal phone bill – you will find the instructions on page 6.

## **Money**

▶ page 8

These instructions will tell you how to empty the cash box, find out the amount of money the payphone has taken, and reset the counter to £0.00.

## Making a normal payphone call

**Before you make a normal payphone call**, make sure you have enough cash ready. Put in the money as soon as your call is answered or the call will be disconnected.

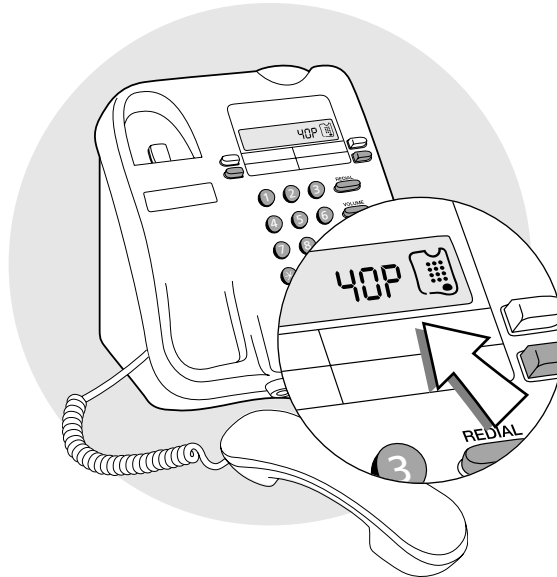

- 1** Lift the handset  
*The display will show PLEASE DIAL*
- 2** Dial the number  
*The display will show the number as you dial it.*
- 3** Wait for your call to be answered
- 4** As soon as your call is answered, put your money in  
*You will need to insert coins to at least the value shown on the display.*  
*The payphone will accept 10p, 20p, 50p and £1 coins, and any other coins or tokens you program it to accept (see page 26 for instructions).*
- 5** As you talk, keep an eye on the display  
*The display will show how much money you have left. 20 seconds before the money runs out, the display will flash and you will hear a series of beeps. You can add more money at any time during the call, but remember that the payphone does not return any unused coins.*

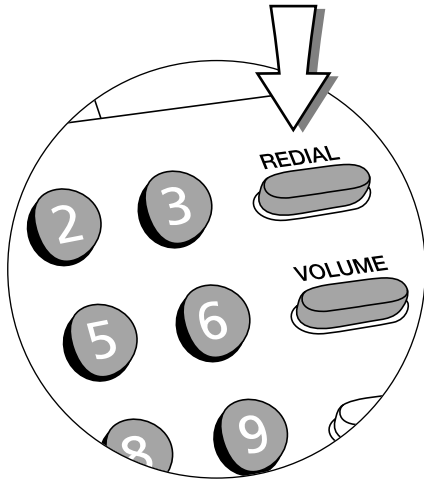

---

**To redial the last number you dialed,  
don't hang up**

- Press **REDIAL** when you hear the engaged tone.

**To call a pre-programmed memory number, you will  
need to lift the handset and press the appropriate  
Memory button.**

Wait for your call to be answered. As soon as your call is  
answered, put your money in.

This feature can be activated by following the instructions and using either your PIN or the cash box key.

It is best to use your PIN for the features where you have a choice of methods, as it is easier and more secure.

## Making an Owner call using your PIN

- 1 Lift the handset
- 2 Press \*  
*The display will show PIN*
- 3 Enter your PIN
- 4 Press the white button below the volume button  
*The display will show OWNER CALL*
- 5 Dial the number – you do not need to put any money in when your call is answered  
*When you have finished your calls, hang up. The payphone will then be ready to make normal payphone calls.*

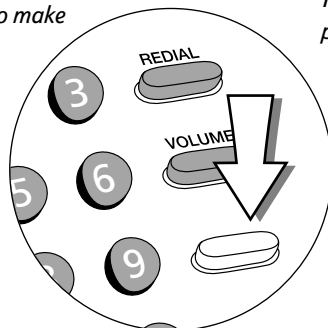

## Making an Owner call using your cash box key

- 1 Lift the handset
- 2 Unlock the cash box and leave the key in the lock
- 3 Press the white button below the volume button
- 4 Lock the cash box and remove the key  
*The display will show OWNER CALL*
- 5 Dial the number – you do not need to put any money in when your call is answered  
*When you have finished your calls, hang up. The payphone will then be ready to make normal payphone calls.*

## Answering calls

When your payphone rings, you just need to lift the handset to answer the call.  
The caller will hear a series of beeps which will let them know they are calling a payphone.

**Everyday features:**  
*Making and answering calls*





## Emptying the cash box

---

You will need the cash box key

---

- 1** Lift the handset and rest it on the table or floor
- 2** Unlock the cash box and lift the cover
- 3** Empty the cash box tray
- 4** Replace the tray and lock the cash box

*You should check that you have locked the cash box securely by trying to lift the cover.*

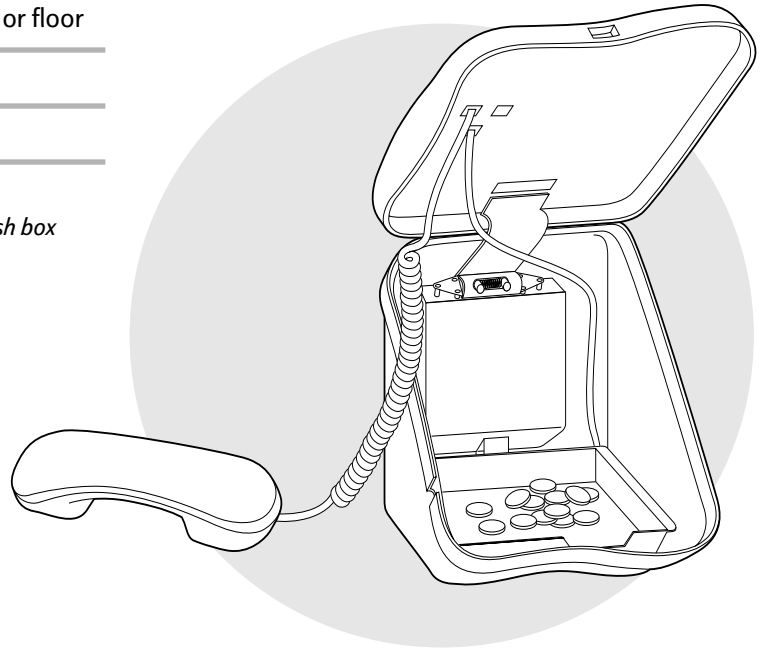

## Checking the total money taken using your PIN

- 1 Lift the handset
- 2 Press \*  
*The display will show PIN*
- 3 Enter your PIN
- 4 Press \*66  
*The display will show MONEY*
- 5 Press # to see how much money the payphone has taken since it was last reset
- 6 Press # again to see how much money the payphone has taken since it was first used.

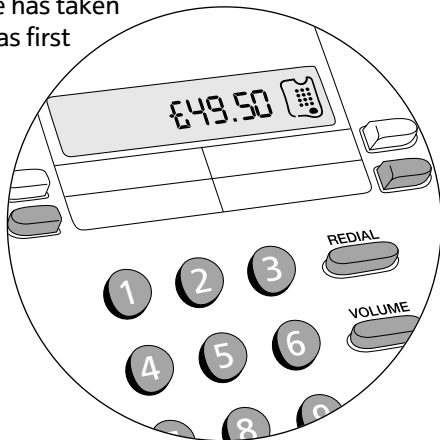

## Checking the total money taken using the cash box key

- You will need the cash box key
- 1 Lift the handset
  - 2 Unlock the cash box and leave the key in the lock
  - 3 Press \*66  
*The display will show MONEY*  
*If it does not, hang up, lift the handset and try entering \*66 again.*
  - 4 Press # to see how much money the payphone has taken since it was last reset.

**After the last step of either method, you can reset the amount to £0.00**

Press 0, then #.

*The display will flash once to confirm that you have reset it to £0.00.*

This feature can be activated by following the instructions and using either your PIN or the cash box key.

It is best to use your PIN for the features where you have a choice of methods, as it is easier and more secure.

# Extra features

You can use these features to personalise your BT Contour 50 Payphone for your precise needs.

<i>Type of feature</i>	<i>Features</i>	<i>Page</i>
Barring	Barring certain outgoing calls	12
	Barring calls made with fake coins or tokens	13
	Barring incoming calls	14
	Setting the ringer switch	15
	Barring old coins from being used	16
Call handling	Withholding your number	17
	Setting the identification tone	18
	Setting the Operator tone	19
	Setting the privacy feature	20
	Setting an automatic switchboard code	21
	Setting a manual switchboard code	22
	Removing a switchboard code	23
Charging	Setting call charges	24
	Setting the minimum fee	25
	Programming new coins or tokens	26
	Programming exception codes	27
	Cancelling exception codes	28
	Charging for calls to Directory Enquiries	28
Payphone settings	Setting the payment timer	29
	Programming the Memory buttons	30
	Setting the time and day	32
	Changing your PIN	33
	Setting the dialling mode	33

# How to get started

Extra features:  
How to get started

You will need to use these instructions to start the programming mode when you want to change any of the extra features. Once you have started the programming mode, you can change as many features as you like as long as you don't hang up. If you hang up before you have finished programming, you will find a diagram to remind you how to start the programming mode in the left margin of every other page.

---

You will need the cash box key

---

- 1 Lift the handset

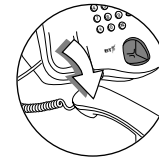

- 2 Unlock the cash box and leave the key in the lock

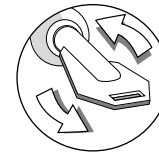

The display will show **PIN**

---

- 3 Enter your PIN
- 

- 4 Press **#**

The display will show **MONEY**

---

*If it still shows **PIN**, the PIN was incorrect - try entering it again. If you enter the wrong PIN more than once, reset your payphone using the instructions on page 34. The PIN will go back to 2802. Remember to change it again using the instructions on page 33.*

---

- 5 Choose the feature you want to program and follow the instructions on the following pages.

## Extra features:

### Barring

# Barring certain outgoing calls

## ① Start programming

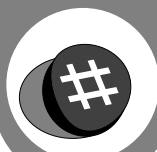
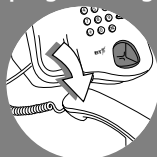

You can choose to prevent calls being made from your payphone to certain types of numbers.

*If a new phone code is launched and your payphone shows **BARRED** when you dial the new code, it is because the payphone does not recognise the code. You will need to program the new code in as an exception code, using the instructions on page 27.*

*If the payphone says a number is barred when it shouldn't be, contact the Helpdesk. For contact details, see page 2.*

For information about the types of calls you can bar and the settings on your payphone when you first get it, see the table on the right.

## ① Start programming, if you haven't already

### 2 Press \*22#

*The display will show **FREE** ✓*

### 3 Press **Memory 1** to choose the type of call you want to bar or allow, and keep pressing it to scroll through the choices

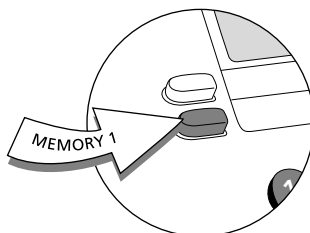

### 4 Press **Program 2** to bar or allow calls

*The display will show the call type and whether it is barred or unbarred, eg **PREMIUM** ✓ to confirm the setting you have chosen*

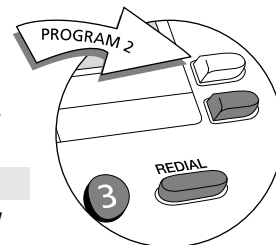

### 5 Press **#**

*The display will flash once to confirm the barred and unbarred numbers have been set.*

### 6 Repeat steps 3 and 4 until you have finished

### 7 Program another feature or lock the cash box, remove the key and replace the handset.

## Barring calls made with fake coins or tokens

If you're having a problem with people using fake coins or tokens, known as slugs, you can program your payphone to reject them.

Call type	barred $\times$ unbarred $\checkmark$	types of calls barred
FREE	$\checkmark$	Calls that are normally free, eg 0800 and 0500 numbers
OPERATOR	$\times$	Calls to the Operator on 100 and 151
DIR ENQ	$\checkmark$	Calls to Directory Enquiries on 192 or 153
WORLD	$\checkmark$	Calls to any other countries
ASIA	$\checkmark$	Calls to Australia, New Zealand, Singapore and Hong Kong
AMERICA	$\checkmark$	Calls to America, Canada and the Caribbean
EUROPE	$\checkmark$	Calls to Europe
EIRE	$\checkmark$	Calls to the Republic of Ireland on numbers beginning with 00353
PREMIUM	$\times$	Calls to information services, eg numbers beginning with 090
MOBILE	$\checkmark$	Calls to mobile phones
NATIONAL	$\checkmark$	Calls outside your local area, eg numbers beginning with 01 and 02
LOCAL	$\checkmark$	Calls to local phone numbers and local rate numbers, eg numbers beginning with 2 to 9, and 0845 numbers

① Start programming, if you haven't already

2 Press  $\ast 8 6 \#$

The display will show `TOKEN R 1`

3 Press  $\# \#$

The display will show `SLUG`

4 Insert the slug 8 times

The display will show `SLUG OK`

5 Program another feature or lock the cash box, remove the key and replace the handset.

## Barring incoming calls

①  
Start programming

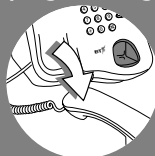

You can stop your payphone accepting any incoming calls.

① Start programming, if you haven't already

2 Press \*46#

The display will show ANSWER x

if incoming calls are barred

or

ANSWER ✓

if incoming calls are allowed.

3 Press Program 2 to change the setting

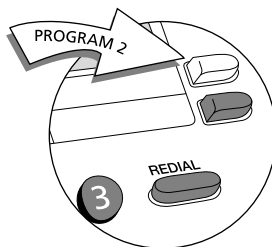

4 Press #

The display will show SET RINGER SWITCH ON

if incoming calls are allowed

or

SET RINGER SWITCH OFF

if incoming calls are barred.

5 If you have barred incoming calls, switch the ringer volume to **Off** – see next page for details

*If you leave the ringer volume on High or Low, the payphone will ring every time someone calls even if you have barred incoming calls, but you will not be able to answer.*

6 Program another feature or lock the cash box, remove the key and replace the handset.

## Setting the ringer switch

You can switch the ringer off or switch the volume between high and low.

---

You will need the cash box key

---

- 1** Unlock the cash box and lift the cover
  - 2** Switch the ringer to the volume you want – you can choose high, low or off
  - 3** Close the cover and lock the cash box.
- 

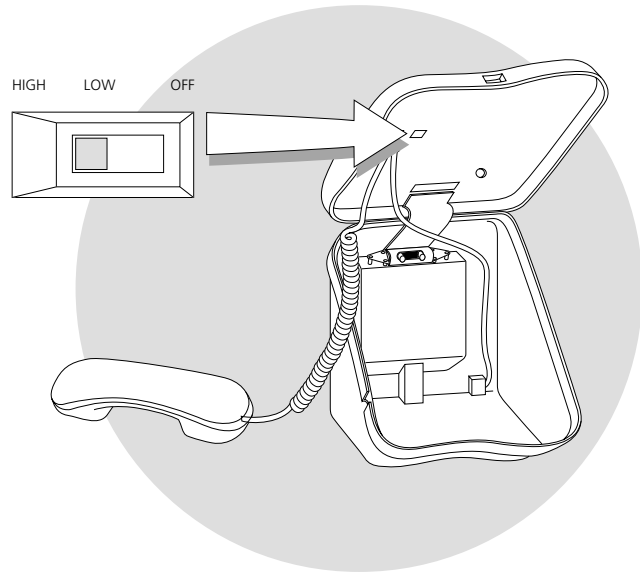



## Barring old coins from being used

①  
Start programming

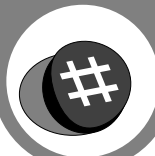
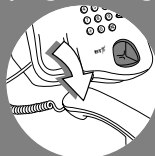

You can stop a coin from being used to make calls, for instance if the design changes or it is withdrawn from circulation.

① Start programming, if you haven't already

2 Press \*26#

The display will show **COIN 10P ✓**  
to show that 10p coins are allowed.

3 Press **Memory 1**  
to choose the coin  
you want to bar

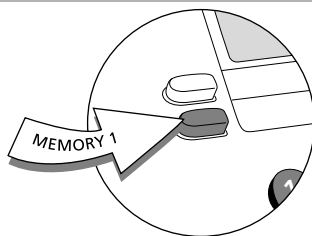

4 Press **Program 2**  
to stop the coin  
being used

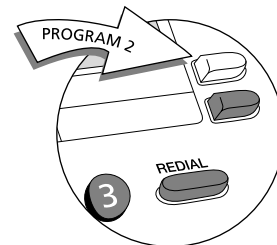

The display will show **COIN 10P x**  
to show that the coin is barred.

5 Press #

The display will flash once to confirm the coin has  
been barred.

6 Repeat steps 3 to 5 until you have finished

7 Program another feature or lock the cash box,  
remove the key and replace the handset.

# Withholding your number

If your payphone is not on a payphone line, it may display your number to people you are calling.

You can withhold your number to stop it from being available for people to call the payphone back.

**This service is not available on payphone lines.**

---

① Start programming, if you haven't already

---

2 Press \*23#

*The display will show* WITHHELD ✓

*if your number is withheld*

*or* WITHHELD x

*if your number is not withheld.*

---

3 Press **Program 2**  
to change the setting

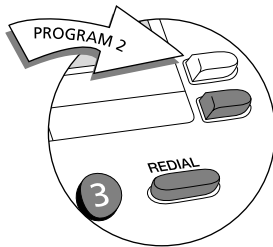

---

4 Press #

*The display will flash once to confirm this service is set.*

---

5 Program another feature or lock the cash box,  
remove the key and replace the handset.

## Setting the identification tone

**1**  
Start programming

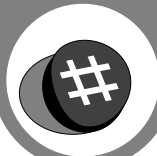
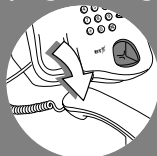

Callers to your payphone will hear a tone to tell them that they are calling a payphone. BT Operators will recognise this tone and will not connect reverse charge calls. You can choose to turn this tone off, although BT recommend that you leave it on.

**1** Start programming, if you haven't already

**2** Press \*43#

The display will show `PID TONE ✓`

if the tone is on

or

`PID TONE x`

if the tone is off.

**3** Press **Program 2** to change the setting

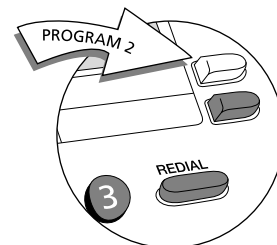

**4** Press #

The display will flash once to confirm the setting has been changed.

**5** Program another feature or lock the cash box, remove the key and replace the handset.

## Setting the Operator tone

When anyone dials 100 from the payphone, the Operator will hear a tone which tells them that the call is from a payphone so they won't directly connect or transfer calls for the caller. You can choose to turn this tone off, although BT recommend that you leave it on.

---

① Start programming, if you haven't already

---

2 Press \*67#

The display will show `OP TONE ✓`

if the tone is on

or

`OP TONE x`

if the tone is off.

---

3 Press **Program 2** to change the setting

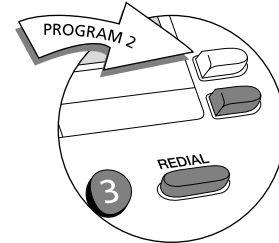

---

4 Press #

The display will flash once to confirm the Operator tone has been changed.

---

5 Program another feature or lock the cash box, remove the key and replace the handset.

## Setting the privacy feature

①  
Start programming

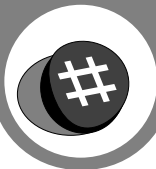
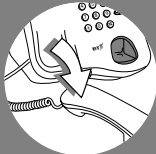

If you have another phone connected to the same line as your payphone, you can transfer calls between them, but this also means that it's possible for calls made on one phone to be overheard on the other.

If you don't want to transfer calls and you would prefer that people can't overhear calls on the payphone, switch the privacy feature on. The factory setting for the privacy feature is off.

*If you want to transfer calls to the payphone, make sure the payphone handset is lifted before you put down the handset on the other phone.*

① Start programming, if you haven't already

2 Press \*77#

The display will show PRIVATE ✓

if privacy is on

or

PRIVATE x

if privacy is off.

3 Press Program 2 to change the setting

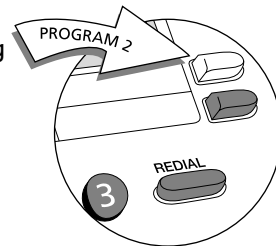

4 Press #

The display will flash once to confirm the privacy feature is set.

5 Program another feature or lock the cash box, remove the key and replace the handset.

## Setting an automatic switchboard code

If your payphone is connected to an internal switchboard, you can choose whether the payphone will dial an access code such as 9 for an outside line, or whether callers will have to dial it themselves.

*If callers have to manually dial a code between 2 and 9 for an outside line, the payphone will charge the call at local rates. For more information, contact the Helpdesk. For contact details, see page 2.*

---

① Start programming, if you haven't already

---

2 Press \*72#

The display will show PBX CODE --

---

3 Enter the code

---

4 Press #

The display will show AUTOMATIC

---

5 Press #

The display will show PAUSE 3.5

*This is the length of time the payphone waits to get an outside line before it dials the phone number.*

---

6 To change the length of the pause, you can

- increase the pause by pressing **Program 2**
- decrease the pause by pressing **Memory 2**.

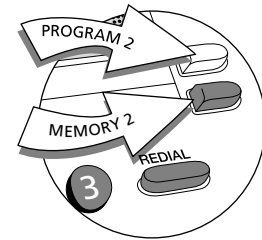

---

7 Press #

The display will show PBX CODE

and the code number

you programmed to confirm your choice.

---

8 Program another feature or lock the cash box, remove the key and replace the handset.

## Setting a manual switchboard code

①  
Start programming

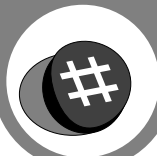
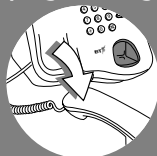

① Start programming, if you haven't already

2 Press \*72#

The display will show PBX CODE --

3 Enter the code

4 Press #

The display will show AUTOMATIC

5 Press **Memory 1**

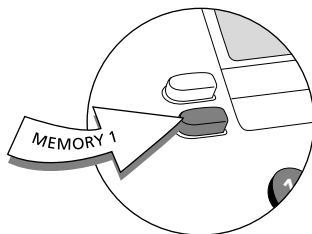

The display will show USER KEYED

This is the length of time the payphone waits to get an outside line before it dials the phone number.

6 Press #

The display will show EXTENSION -

7 Press the first digit of your extension numbers

This will tell the payphone which extensions it may call.

8 Press #

The display will show PBX CODE  
with the code number  
you programmed to confirm your choice.

9 Program another feature or lock the cash box, remove the key and replace the handset.

## Removing a switchboard code

---

① Start programming, if you haven't already

---

2 Press \*72#

*The display will show  
with the number you  
programmed.*

PBX CODE

---

3 Press REDIAL

*The display will show*

PBX CODE --

---

4 Press #

*The display will show*

PBX

---

5 Program another feature or lock the cash box,  
remove the key and replace the handset.



## Setting call charges

You can choose which rate your payphone will charge calls at. The rate decides the number of seconds callers get for 10p. It is first set to charge rate 100, but you can choose any rate from 20 to 500. The table on the right shows how many seconds callers will get for 10p at some example charge rates.

### ① Start programming, if you haven't already

#### 2 Press \*24#

*The display will show the current charge rate.*

*To change the charge rate, you can*

– increase the charge rate by pressing

**Program 2**

– decrease the charge rate by pressing

**Memory 2**

– enter a charge rate using the number keys.

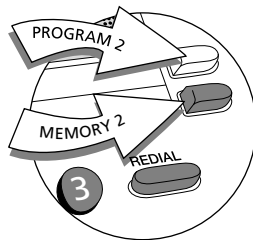

#### 3 Press #

*The display will flash once to confirm the setting.*

#### 4 Write the new charges on your payphone notice

### 5 Program another feature or lock the cash box, remove the key and replace the handset.

Type of call                      Number of seconds callers get for 10p at some example charge rates

Band	Rate	75	100	150	200
Local	Daytime	73.3	55.0	36.7	27.5
	Cheap	73.3	55.0	36.7	27.5
	Weekend	73.3	55.0	36.7	27.5
National	Daytime	73.3	55.0	36.7	27.5
	Cheap	73.3	55.0	36.7	27.5
	Weekend	73.3	55.0	36.7	27.5
Mobile	Daytime	10.7	8.0	5.3	4.0
	Cheap	16.0	12.0	8.0	6.0
	Weekend	16.0	12.0	8.0	6.0
Premium	Daytime	8.0	6.0	4.0	3.0
	Cheap	9.3	7.0	4.7	3.5
	Weekend	9.3	7.0	4.7	3.5
Eire	Daytime	10.7	8.0	5.3	4.0
	Cheap	14.7	11.0	7.3	5.5
	Weekend	14.7	11.0	7.3	5.5
Europe	Daytime	8.0	6.0	4.0	3.0
	Cheap	8.0	6.0	4.0	3.0
	Weekend	8.0	6.0	4.0	3.0
America	Daytime	10.7	8.0	5.3	4.0
	Cheap	10.7	8.0	5.3	4.0
	Weekend	10.7	8.0	5.3	4.0
Asia	Daytime	8.0	6.0	4.0	3.0
	Cheap	8.0	6.0	4.0	3.0
	Weekend	8.0	6.0	4.0	3.0
World	Daytime	2.7	2.0	1.3	1.0
	Cheap	2.7	2.0	1.3	1.0
	Weekend	2.7	2.0	1.3	1.0

### ① Start programming

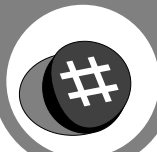
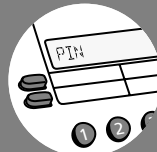
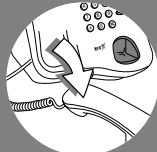

## Setting the minimum fee

You can choose how much callers will need to put into the payphone to start their call. The minimum fee will automatically adjust to reflect the time and day of the call, and the distance of the call.

---

① Start programming, if you haven't already

---

2 Press \*64#

*The display will show the current minimum fee.*

---

3 To change the minimum fee, you can

- increase the fee by pressing **Program 2**
- decrease the fee by pressing **Memory 2**.

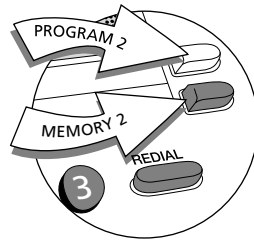

---

4 Press ##

*The display will flash once to confirm the minimum fee is set.*

---

5 Program another feature or lock the cash box, remove the key and replace the handset.

## Programming new coins or tokens

①  
Start programming

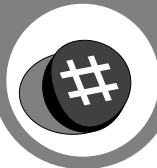
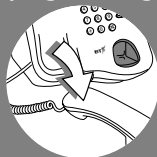

You can program your payphone to recognise and accept new coins or tokens. For example, if you want the payphone to accept tokens from a games machine, you can decide how much they will be worth and the payphone will accept them. The instructions below will ask you to insert eight of the new coins or tokens. It is better to use eight different ones rather than the same one eight times, so that the payphone recognises the slight differences in the coins or tokens.

If the new coin or token is too similar to an existing coin, the payphone will not be able to accept it.

① Start programming, if you haven't already

2 Press \*86#

The display will show **TOKEN R 1**

3 Insert the first coin or token

The display will show **TOKEN R 2**

4 Continue to insert coins or tokens until the display shows **TOKEN R £0.00**

If the display shows **ERROR**

*the new coin or token is too similar to an existing coin and can't be used.*

5 To set the value of the coin or token you can

- increase the value by pressing **Program 2**
- decrease the value by pressing **Memory 2**
- enter a value using the number keys.

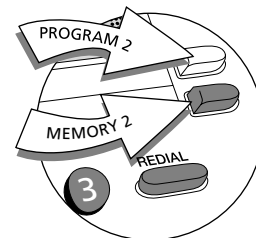

6 Press #

*If you would like to program another coin or token repeat steps 3 to 6.*

7 Program another feature or lock the cash box, remove the key and replace the handset.

## Programming exception codes

Your payphone uses the first few digits of any number dialled to determine the charge rate for the call. You can program exceptions to the normal settings. For instance, you could set a certain rate for international calls.

① Start programming, if you haven't already

2 Press \*39#

The display will show -----

If you have previously entered exception codes, press **Program 2** or **Memory 2** to move through the list.

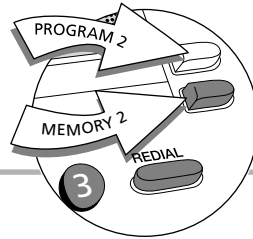

3 Enter the number

You can enter up to 6 digits.

4 Press #

The display will show BARRED

5 Press **Memory 1** to move through the different call charge types

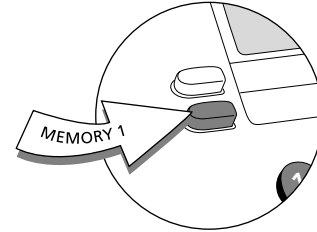

The different call charge types are: BARRED, FREE, FEE £0.50, DIR ENQ, WORLD, ASIA, AMERICA, EUROPE, EIRE, PREMIUM, MOBILE, NATIONAL AND LOCAL.

If you want to charge a fixed fee for a type of call, regardless of the length, go to FEE £0.50 and use **Program 2** to increase the value or **Memory 2** to decrease the value. If you choose this option, the caller will only have to put in the fixed fee – the payphone will not ask for more money no matter how long the call is.

6 Press #

The display will show -----

If you would like to program another exception code, repeat steps 3 to 6.

7 Program another feature or lock the cash box, remove the key and replace the handset.

## Cancelling exception codes

You can cancel any of the exception codes you have previously set.

### 1 Start programming

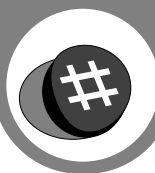
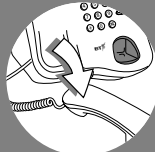

### 1 Start programming, if you haven't already

#### 2 Press \*39#

The display will show any exception codes you have previously set.

Press **Program 2** to scroll up through them and **Memory 2** to scroll down through them.

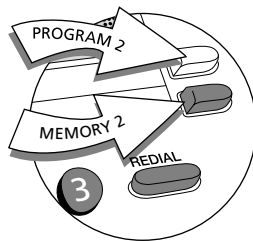

### 3 Press REDIAL when you come to the exception code you want to cancel

#### 4 Press #

The display will flash once to confirm the code is cancelled.

### 5 Program another feature or lock the cash box, remove the key and replace the handset.

## Charging for calls to Directory Enquiries

Your payphone is set to charge 50p for a call to Directory Enquiries. If you would like to, you can alter this charge.

### 1 Start programming, if you haven't already

#### 2 Press \*37#

The display will show **FEE £0.00**

### 3 To alter the fee for a call to Directory Enquiries, you can

- increase the fee by pressing **Program 2**
- decrease the fee by pressing **Memory 2**

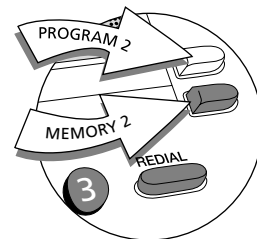

#### 4 Press #

The display will flash once to confirm the fee is set.

### 5 Program another feature or lock the cash box, remove the key and replace the handset.

## Setting the payment timer

You can adjust the length of time callers have to put money in before the payphone disconnects them. The factory setting is 39 seconds after you have finished dialling.

① Start programming, if you haven't already

2 Press \*78#

The display will show **TIMEOUT 39**  
to show the factory  
setting of 39 seconds.

3 To change the length of time, you can

- increase the time by pressing **Memory 3**
- decrease the time by pressing **Memory 4**
- enter a time using the number keys.

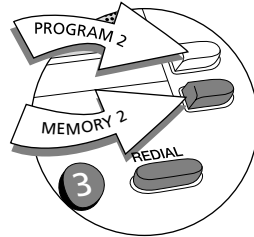

4 Press #

The display will flash once to confirm the length of time has been set.

5 Program another feature or lock the cash box, remove the key and replace the handset.

## Programming the Memory buttons

### 1 Start programming

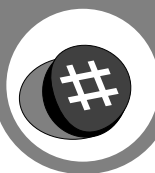
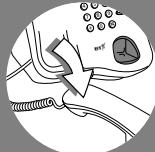

You can program two memory numbers, such as a local taxi firm, into the payphone. The caller just has to press a **Memory button** to dial the number.

1 Start programming, if you haven't already

2 Press \*63#

The display will show ENTER TEL

3 Enter the phone number you want to program

You can enter up to 22 digits. If you make a mistake, press **REDIAL** # and start again. If callers need to dial a code for an outside line, remember to include the code for an outside line before the number you program.

4 Press the **Memory button** you want to program the number into

The display will show the type of call band the payphone will use for calls to this number, for instance LOCAL

5 Press **Memory 1** to change the call band, and keep pressing it to scroll through the choices - it doesn't matter if you have programmed a phone number into the **Memory 1** button, you can still use it to select a call band

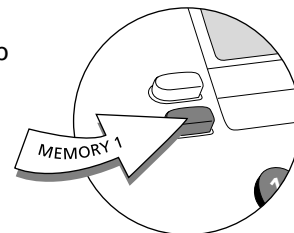

To set a fixed fee, press **Memory 1** until the display shows FEE £0.50 and use **Program 2** to increase the value or **Memory 2** to decrease the value. If you choose this option, the caller will only have to put in the fixed fee – the payphone will not ask for more money, no matter how long the call is.

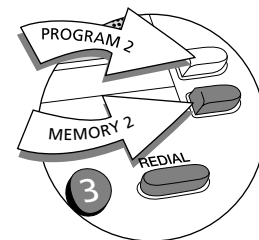

6 Press #

The display will show ENTER TEL

- 
- 7** Repeat steps 3 to 6 until you have programmed all the **Memory buttons** you want

*If you want to offer callers a choice of display languages, don't program a phone number into **Memory 2**.*

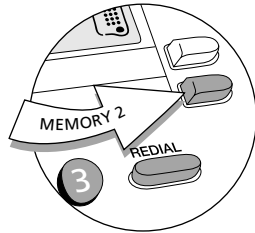

- 
- 8** Lift up the cash box cover

- 
- 9** Push the display release lever to release the display cover

*The lever is under the sticker marked **DISPLAY RELEASE**. Press the part of the lever under the **D** of the sticker – you will need to press quite hard. The front of the display cover will come out slightly. It is best to slide something flat under this corner and gently lever the display cover out.*

- 
- 10** Write the name of the business or service in the space on the card

- 
- 11** Replace the card and press the display cover into place until it clicks

- 
- 12** Program another feature or lock the cash box, remove the key and replace the handset.



## Setting the time and day

### 1 Start programming

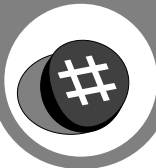
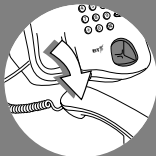

Your payphone uses the time and the day to set call charges, so it is important that it is set correctly. You will need to change the time on your payphone when the clocks go forward in spring and back in autumn.

1 Start programming, if you haven't already

2 Press \*84#

The display will show **TIME** and the current time.

3 Check the time is correct (the payphone uses the 24 hour clock). To change the time, you can

- move the time forward by pressing **Program 2**
- move the time backward by pressing **Memory 2**
- enter the current time using the number keys.

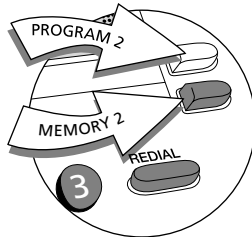

4 Press #

5 Press \*32#

The display will show the current day.

6 Check the day is correct. To change the day, you can

- move the day forward by pressing **Program 2**
- move the day backward by pressing **Memory 2**.

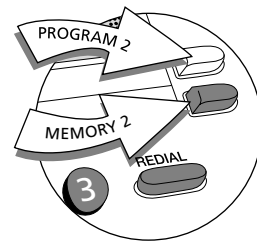

7 Press #

8 Program another feature or lock the cash box, remove the key and replace the handset.

## Changing your PIN

You can change your PIN to one that's easier to remember. Remember to change your PIN straight away if you think someone might have found out what it is. You will need your old PIN to enter the programming mode, so if you have forgotten it or can't find it, reset your payphone using the instructions on page 34. This will return the PIN to the default setting of 2802. You should then change this default PIN to one you have chosen.

① Start programming, if you haven't already

2 Press \*74#

The display will show SET TO ----

3 Enter your new PIN

If you make a mistake, finish entering a number then enter your new PIN again.

4 Press #

The display will flash once to confirm your new PIN is set.

5 Program another feature or lock the cash box, remove the key and replace the handset.

## Setting the dialling mode

The normal setting is TouchTone™ dialling. If the dialling tone doesn't go away when you dial a number, switch to Pulse dialling and try again.

① Start programming, if you haven't already

2 Press \*34#

The display will show the current dialling mode.

3 Press Program 2 to change the dialling mode

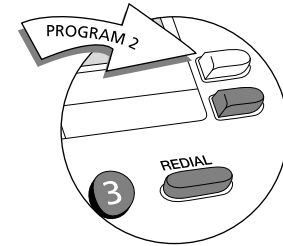

4 Press #

The display will flash once to confirm the dialling mode is set.

5 Program another feature or lock the cash box, remove the key and replace the handset.

# Troubleshooting

Use this section to help you try and solve any problems you may have with your payphone.

**If**

**you should**

there is no dialling tone

check that the payphone is still plugged into the socket.

your payphone does not ring

check:

- that the ringer switch is on – *see page 15*
- that you have not barred incoming calls
- that you don't have too many phones connected to the line

there is nothing on the display

check that the payphone is still plugged into the socket.

If it is plugged in, try resetting your payphone:

*When you reset your payphone, the PIN will return to the default 2802. You will need to change it to one you have chosen, using the instructions on page 33.*

- 1 Unplug the payphone lead from the phone socket
- 2 Lift the handset
- 3 Unlock the cash box and lift the cover
- 4 Press the reset button

*The button is just above the hinge and is marked by a label. You will need a matchstick or a similar object to press it.*

- 5 Close the cover and lock the cash box
- 6 Replace the handset
- 7 Plug the payphone lead back into the phone socket
- 8 Check the payphone still shows the correct time and day  
– *see page 32.*

If	you should
the display shows 'PIN'	check you have locked the cash box and removed the key.
the display shows 'EMERGENCY'	check: <ul style="list-style-type: none"> <li>■ that the cash box is not full</li> <li>■ that the coin slot is not jammed.</li> </ul>
a coin has become jammed	try sharply tapping the side of the payphone, or gently shaking it. Once you have dislodged the coin, you will have to reset your payphone – <i>see page 34</i> .
the display shows 'BARRED'	check that the payphone allows the type of calls you are trying to make – <i>see page 12</i> . If the payphone is programmed correctly but still shows <b>BARRED</b> , contact the Helpdesk. For contact details, see page 2.

<b>If</b>	<b>you should</b>
the payphone won't take coins	check: <ul style="list-style-type: none"><li>■ that the cash box is not full</li><li>■ that the coin slot is not jammed</li></ul> If this doesn't work, try resetting your payphone – <i>see page 34</i> .
you forget your new PIN	reset your payphone using the instructions on page 34. Once you have done that, do not forget to replace the default PIN with one you have chosen.
you forget the payphone's original PIN	reset your payphone using the instructions on page 34. Once you have done that, do not forget to replace the default PIN with one you have chosen.
you lose the cash box keys	call the Tetrel Key Helpline on 0800 373 085. You will need the key number or the serial number of your payphone. These numbers should be written on page 2. If you did not write the numbers down, you will find the serial number on the bottom of the payphone. There is a charge for replacing cash box keys.

**If**

the dialling tone won't go away

you get a message when you are dialling saying 'This service is not available. Please contact BT.'

the previous solutions don't work

*you have a problem not covered in this section*

**you should**

try setting the dialling mode to the other option (pulse or tone) – *see page 33*. If you find that you have to set it to 'pulse' to make the dialling tone go away when you are dialling, contact the Helpdesk. For contact details, see page 2.

check whether you have programmed your payphone to withhold your phone number – *see page 17*. If you have a payphone line, this service is not available and should be switched off.

try resetting your payphone using the instructions on page 34.

*please contact us the Helpdesk – for contact details, see page 2.*

# Technical

## Protecting against vandalism and theft

Your Payphone Contour 50 is designed for use in constantly supervised and sheltered sites. It is not recommended for locations where there is any risk of vandalism or theft.

## Connecting to the BT Network

The Payphone Contour 50 is approved:

- to provide a public payphone service
- for multi-frequency (tone) and loop disconnect (pulse) dialling
- for inductive coupling to appropriate hearing aids
- for Call barring
- for use with compatible:
  - PBXs
  - PABXs
  - key systems
  - dealerboards
  - key and lamp units
  - automatic call distributors which provide a BS6312 compatible port and meet the requirements for simple phones. Your supplier will be able to provide you with a list of compatible apparatus.

## Maintaining your Payphone Contour 50

Keep the Payphone clean and make sure that the coin slots are always free of obstructions.

Do not polish the keypad.

## Requirements for payphone notices

OFTEL Regulations require you to display a payphone notice which gives the following information:

- details of limitations of access to the 100 Operator service
- what happens to unused coins
- the minimum payment to make a call
- the method of payment
- the full postal address of the location of the payphone
- the person who should be contacted about caller complaints
- how calls are charged
- an indication that 999 and 112 calls are free
- a warning that calls may be overheard where other extensions are connected to the same line.

## VAT liability

If you are registered for VAT, you will be required by HM Customs and Excise to account for the VAT on the cash you collect in your Payphone Contour 50.

## Liability for calls

You must pay all the BT call charges. Calls are charged at standard BT rates.

You can set the rate that you charge for calls made from your Payphone Contour 50.

You might want to use the money you collect to contribute to the call charges and rental charges.

## BT Chargecard calls

Calls made with a BT Chargecard which is charged to your Payphone Contour 50's phone number will be charged on your phone bill in the normal way. You will not be charged for calls made with other BT Chargecards.

# Index

Barring			
calls made with			
fake coins	.....	13	
incoming calls	.....	14	
outgoing calls	.....	12	
Calls			
answering	.....	7	
barring	.....	12-14	
making	.....	4	
making another call	.....	5	
making Memory calls	.....	5	
Owner calls	.....	6	
redialling	.....	5	
without coins	.....	6	
Cash box key	.....	2, 36	
Cash box tray			
emptying	.....	8	
Charges			
rates	.....	24	
setting	.....	24	
Coins			
jammed	.....	35	
programming new	.....	26	
barring	.....	16	
when to put in	.....	4	
Day			
changing	.....	32	
Dialling mode			
setting	.....	33	
Dialling tone, no	.....	34	
Directory Enquiries	.....	28	
Display			
problems with	.....	35	
Display cover			
removing	.....	31	
Exception codes			
programming	.....	27	
cancelling	.....	28	
Helpdesk contact details	.....	2	
Identification tone			
setting	.....	18	
Key			
lost	.....	36	
Memory buttons			
programming	.....	30	
using	.....	5	
Minimum fee			
setting	.....	25	
Money			
checking	.....	9	
resetting	.....	9	
Operator tone			
setting	.....	19	
Owner calls	.....	6	
PBX			
see Switchboard			
Payment timer			
setting	.....	29	
PIN			
changing	.....	33	
Privacy			
setting	.....	20	
Programming	.....	11	
Reset button	.....	34	
Resetting	.....	34	
Ringer switch	.....	15	
Serial number	.....	2	
Slugs			
barring	.....	13	
Switchboard			
removing a code	.....	23	
setting an automatic			
code	.....	21	
setting a manual code	..	22	
Time			
changing	.....	32	
Tokens			
programming new	.....	26	
programming fake	.....	13	
Withholding your number	..	17	